



Take on anything.



Kangaroo Industries (Regd.)  
Kangaroo Industries Limited  
Kanin (India)  
Munix (India) Pvt. Ltd.  
KGOC Global LLP

05/2022



PRODUCT CATALOGUE





**About KGOC**

For more than six decades, we have been helping the world to organise businesses and assisting people to bring out their creative best with innovative and high precision products that help to 'Join, Fix or Cut' through our brands - Kangaro, Miles, Munix and Kohe. We are one of the largest manufacturers and suppliers of high quality Staplers, Staples, Staple Removers, Paper Punches, Gun Tackers, Tape Tool, Pneumatic Tools, Industrial Staples, Stitching Wire, Scissors & Kitchen Essentials etc. KGOC brand identity symbolises the unification that signifies flexibility and limitless possibilities to create a new future.

**About Kangaro**

Kangaro, an iconic stationery brand established in the year 1958, offers wide range of Staplers, Staples, Staple Removers, Scissors, Paper Punches, Gun Tackers for both Professional & DIY .

Since its inception, the brand has grown manifold in its reach, mainly because of its commitment to quality and swiftness in responding to market needs with innovative and value added products.

'KANGARO' holds major share of the Indian market in its category and its products are being exported to over 100 countries around the world. Products under this brand are manufactured in-house and are also supplied under the OEM segment to many international brands.

**Infrastructure**

KGOC has seven state-of-the-art manufacturing facilities, which possess high quality machinery for precision engineering. All units are vertically integrated, wherein all manufacturing operations are performed in-house, right from manufacturing of the smallest parts such as spring, rivet etc. to complex multi-part components.



**Development Centre & Tool Room**

KGOC has a well equipped Research and Development (R&D) Centre and an ultra modern Tool Room having all the latest facilities. R&D centre, along with its over 200 quality engineers provides the innovation and design breakthroughs that not only simplify life but also compliment the uncompromising quality benchmarks that we have set for ourselves. There are CAD/CAM/CAE set ups which manufacture using the softwares. CNC wire cuts, CNC EDM machines, CNC Milling Machines and other such machinery and equipment develop quality Tools, Jigs and Fixtures which enable KGOC to manufacture the required international quality end products.



**Quality Policy**

'Quality Culture' runs into every segment of KGOC's working supported by a team of more than 4000 highly qualified professionals, engineers, technocrats and dedicated workers, whose devotion and dedication has become a cornerstone of KGOC's success."We believe that quality is the life line of every business and is committed to satisfying its customers by manufacturing and supplying its products to their entire satisfaction first time and every time with continual up-gradation in the effectiveness of the quality management system."

**Mission**

To be the leading manufacturer and supplier of quality products in the world.

**Vision**

We help people organise their ideas and their life. By enhancing their productivity and efficiency.

**Environmental Policy**

KGOC has a benevolent Environmental Policy which gives weightage to sustainability and green manufacturing procedures. Environmental awareness and sustainability are not mere words at KGOC. Utmost care is taken to maintain greenery on the land on which our factories are built. Our pledge to the environment is very much woven into our DNA, our philosophy and our way of life. Each one of us believes in the ideology to protect the environment and create a sustainable future. We have made huge investments in solar energy.





# STAPLERS

# STAPLERS



## ICON



Metal body with plastic casing. Built-in staple remover & reload indicator.

## HS-J10

**new**



Metal bottom with high quality plastic top. Quick loading mechanism. Built-in staple remover with staple holder & reload indicator.

## M-10



With Keychain



Plastic body super mini stapler with quality steel components. Takes one full strip of 50 staples. Quick loading mechanism. Built-in staple remover & reload indicator.

## MINI-10

**new**

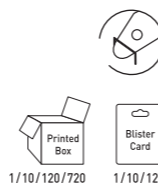

Plastic body mini stapler with quality steel components. Quick loading mechanism. Built-in staple remover & reload indicator.

## HD-10D



Metal body with plastic casing. Built-in staple remover with staple holder.

## HS-10EN



Ergonomically designed metal bottom with high quality plastic top. Quick loading mechanism. Built-in staple remover & reload indicator.

## No.10

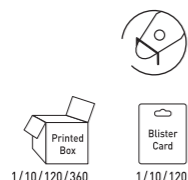

All steel construction with built-in staple remover & reload indicator.

## HS-G10

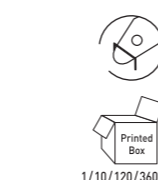

Metal bottom with high quality plastic top. Built-in staple remover & reload indicator.

## HD-10D STAR

**new**

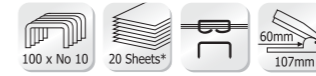

Metal body with plastic casing. Quick loading mechanism. Built-in staple remover & reload indicator.

## HS-10EZ

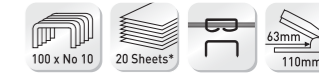

Ergonomically designed metal bottom with high quality plastic top. Quick loading mechanism. Built-in staple remover & reload indicator.

## HS-10A



Metal bottom with high quality plastic top. Built-in staple remover & reload indicator.

## HS-10H

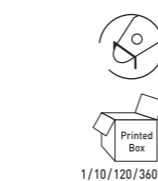

Metal body with plastic casing. Built-in staple remover & reload indicator.

## TRENDY-10M

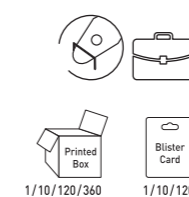

Plastic body mini stapler with quality steel components. Staple storage compartment at the bottom. Quick loading mechanism. Built-in staple remover & reload indicator.

## TRENDY-10

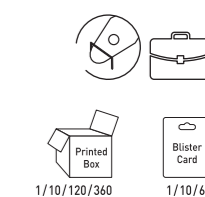

Plastic body stapler with quality steel components. Staple storage compartment at the bottom. Quick loading mechanism. Built-in staple remover & reload indicator.



# STAPLERS

# STAPLERS



## TRENDY-35



1/10/60/120

Half strip plastic body stapler with quality steel components. Quick loading mechanism & reload indicator.

## TRENDY-45



1/10/60/120

Half strip plastic body stapler with quality steel components. Staple storage compartment at the bottom. Quick loading mechanism. Built-in staple remover. Rotating anvil & reload indicator.

## 999

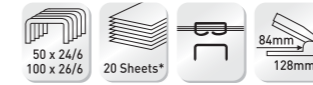

1/10/60/120

All metal half strip stapler.

## HP-10



1/10/60/120

All metal construction with plastic handle. Staples with the slightest action of fingers. Ideal for marking paper for laundry items, sealing vinyl and poly bags for food-stuffs, toys etc.

## HS-10Y



1/10/60/240

Metal bottom with high quality plastic top. Quick loading mechanism. Built-in staple remover & reload indicator.

## HD-45 / HS-45 P

new



1/10/60/120

Metal body half strip stapler with plastic casing. Quick loading mechanism. Rubber feet to avoid desk top from scratches. Built-in staple remover with staple holder & reload indicator.

## HP-45



1/10/30/60

Half strip all metal construction with plastic cover. Quick loading mechanism. Rotating anvil & reload indicator. Ideal for frequent stapling.

## HP-210

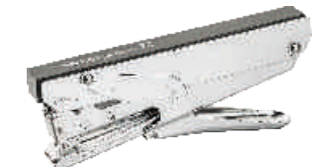

1/10/30/60

Full strip all metal construction with plastic cover. Quick loading mechanism. Rotating anvil & reload indicator. Ideal for shops, stores & offices.

## DS-45



1/10/60/120

All metal half strip stapler. Quick loading mechanism. Rubber base to avoid desk top from scratches. Rotating anvil, built-in staple remover & reload indicator.

## DS-45 N

new

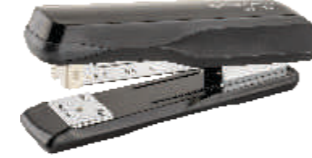

1/10/60/120

Metal body half strip stapler with plastic casing. Quick loading mechanism. Rubber feet to avoid desk top from scratches. Rotating anvil & reload indicator.

## DS-45 L

new



1/10/30

Half strip long throat stapler with plastic casing. Quick loading mechanism & reload indicator. Anti skid feet to avoid desk top from scratches.

## LESS EFFORT



## 555



1/10/60/180

All metal half strip stapler. Chrome plated.

## 555 N



1/10/60/120

All metal half strip stapler. Quick loading mechanism. Built-in staple remover with staple holder & reload indicator.

## LE-10

50% # Less Effort



1/10/60/240



1/10/120

Less effort compact stapler with 50 staples loading. All metal body with plastic casing. Quick loading mechanism. Built-in staple remover with staple holder, Reload indicator.

## LE-35

45% # Less Effort



1/10/60/120



1/10/60

Less effort half strip stapler. All metal body with plastic casing. Quick loading mechanism. Built-in staple remover with staple holder, Reload indicator.



# HEAVY DUTY STAPLERS

# HEAVY DUTY STAPLERS & STAPLE REMOVERS



## HD-23S13

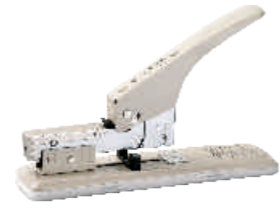

100 23/6-23/13 100 Sheets\* 63mm 170 64 268 Printed Box 1/5/10

All metal construction. Adjustable paper guide that can be used for jam clearing. Rubber base to avoid desk top from scratches. Rear loading. Rotating anvil.

## DS-23S17 FL



# Less stapling force 100 23/6-23/20 170 Sheets\* 80mm 261 85 382 Printed Box 1/5/10

All metal construction with high impact plastic casing. One touch front loading mechanism. Soft grip handle. Staple storage compartment. Anti skid feet to avoid desk top from scratches. Adjustable paper guide with lock. Rotating anvil for different staple sizes.

## DS-23S24 FL



# Less stapling force 100 23/6-23/24 210 Sheets\* 80mm 283 85 382 Printed Box 1/5/10

All metal construction with high impact plastic casing. One touch front loading mechanism. Soft grip handle. Staple storage compartment. Anti skid feet to avoid desk top from scratches. Adjustable paper guide with lock. Rotating anvil for different staple sizes.

## STAPLE REMOVERS

## HD-23S17



100 23/6-23/17 140 Sheets\* 63mm 220 80 284 Printed Box 1/5/10

All metal construction. Adjustable paper guide that can be used for jam clearing. Rubber base to avoid desk top from scratches. Rear loading. Rotating anvil for different staple sizes.

## HD-23S24



100 23/6-23/24 210 Sheets\* 63mm 255 90 300 Printed Box 1/5/10

All metal construction. Adjustable paper guide that can be used for jam clearing. Rubber base to avoid desk top from scratches. Rear loading. Rotating anvil for different staple sizes.



## DS-12S/17



100 23/6-23/17 140 Sheets\* 75mm 225 80 370 Printed Box 1/5/10

Aluminum die casted base with metal handle, makes this machine all time favorite. Anti skid feet to avoid desk top from scratches. Rotating anvil for different staple sizes.

## HD-23L17

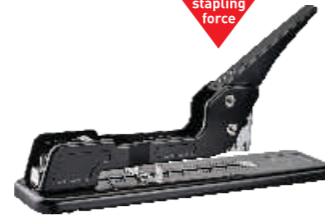

# Less stapling force 200 23/6-23/17 140 Sheets\* 250mm 280 120 520 Printed Box 1/5

All metal construction. Long throat stapler. Adjustable paper guide with lock. Anti skid feet to avoid desk top from scratches. Rotating anvil for different staple sizes.

## SR-45



No.10, 24/6, 26/6, B8(1/4"), US standards 58mm Printed Box 1/10/120/240

Steel jaws. Wide finger grips & non slip surface with locking mechanism. Suitable for 30 sheets.

## SR-100



No.10, 24/6, 26/6, B8(1/4") 141mm Printed Box 1/10/120/480

Pen type staple remover. Specially designed stopper holds removed staples which can be easily disposed by fingers. Suitable for 20 sheets.

## HD-23L24 FL



100 23/6-23/24 210 Sheets\* 250mm 290 120 522 Printed Box 1/5

All metal construction. Long throat stapler. One touch front loading mechanism. Adjustable paper guide with lock. Staple storage compartment. Anti skid feet to avoid desk top from scratches. Rotating anvil for different staple sizes.

## DS-23S13 QL



100 23/6-23/13 100 Sheets\* 60mm 125 60 257 Printed Box 1/10/20

All metal construction with high impact plastic casing. Soft grip handle. Staple storage compartment. Anti skid feet to avoid desk top from scratches. Quick loading mechanism for easy loading. Adjustable paper guide with lock. Rotating anvil.

## SR-300



Upto 23/24 116mm Printed Box 1/10/60/120

All metal construction. Lifts both office & heavy duty staples. In built clamping avoids staple kick back. Suitable for 210 sheets.

## SR-500



Upto 23/17 142mm Printed Box 1/10/60/120

Durable metal construction encased by high impact plastic cover. Easily lifts both office & heavy duty staples. In built clamping avoids staple kick back. Suitable for 140 sheets.

# As compared to normal heavy duty staplers.

\*75-80 gsm paper

# As compared to normal heavy duty staplers.

\*75-80 gsm paper



# PAPER PUNCHES

# PAPER PUNCHES



## PERFO-30

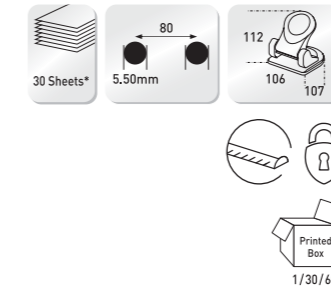

Medium size punch with guide bar. All metal construction. Handle lock for easy storage. Removable chip tray.

## DP-500

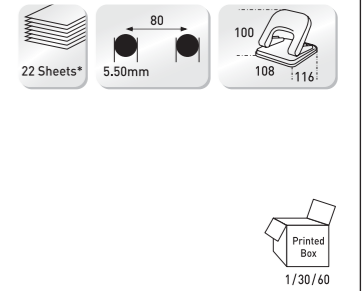

Medium size punch. All metal construction with removable chip tray.

## DP-22

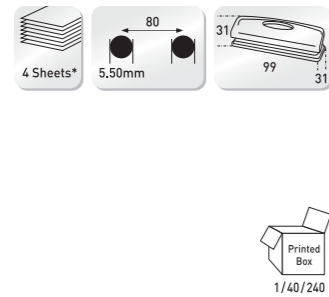

Super mini punch. Ideal for briefcases & students. Metal base. Removable chip tray.

## DP-52

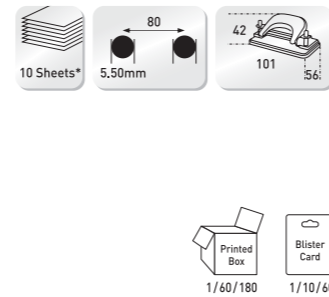

Mini punch. All metal construction with removable chip tray.

## DP-520

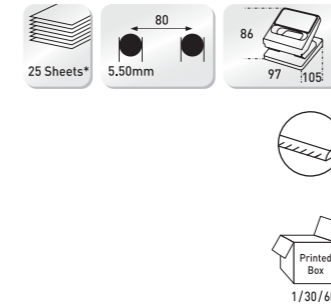

Medium size punch with guide bar. All metal construction with removable chip tray.

## DP-540

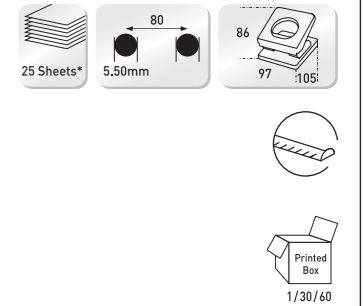

Medium size punch with guide bar. All metal construction with removable chip tray.

## DP-280

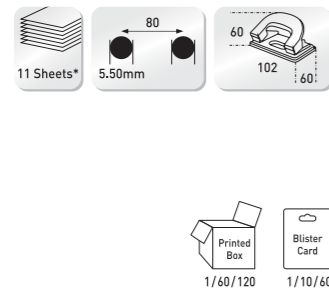

Classic mini punch. All metal construction with removable chip tray.

## DP-480

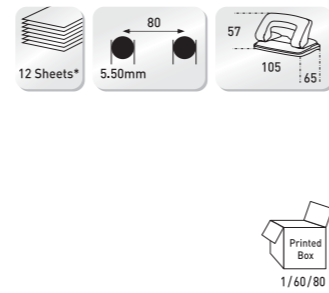

All metal construction with removable chip tray.

## DP-600

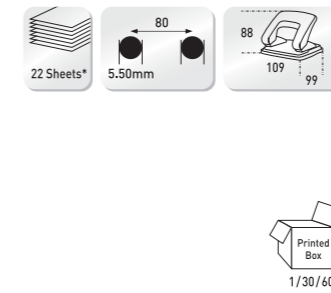

Medium size punch. All metal construction with removable chip tray.

## DP-700

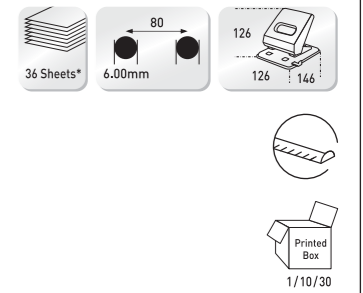

Heavy duty punch. All metal body with high impact plastic casing. Metal guide bar & removable chip tray.

## PERFO-10

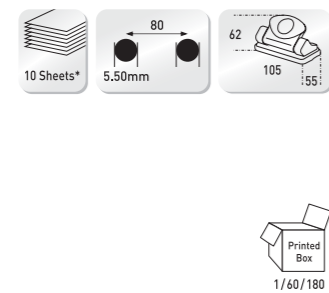

Mini punch. All metal construction. Removable chip tray.

## PERFO-20

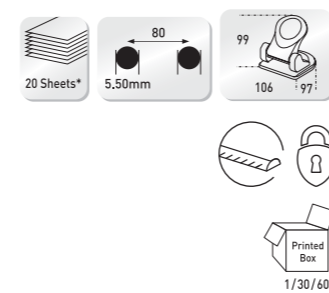

Medium size punch with guide bar. All metal construction. Handle lock for easy storage. Removable chip tray.

## PERFO-40

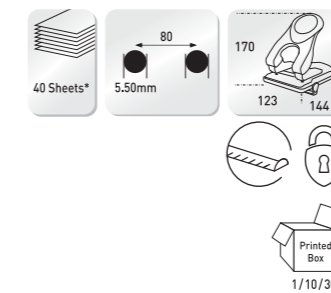

Heavy duty punch with metal guide bar. All metal construction. Handle lock for easy storage. Removable chip tray.

## DP-800

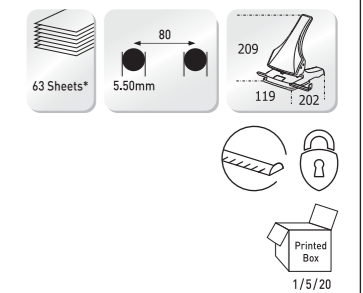

Aluminum die casted heavy duty punch. Handle lock for easy storage. Metal guide bar & removable chip tray.



# PAPER PUNCHES

# PAPER PUNCHES



## DP-900

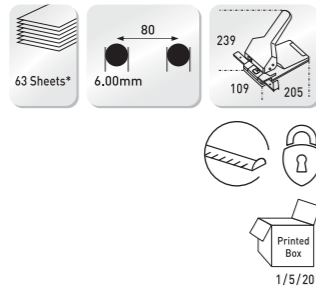

Aluminum die casted heavy duty punch. Handle lock for easy storage. Metal guide bar & removable chip tray.

## ONE HOLE



Chrome plated handy punch with paper chip holder.

## HDP-4160

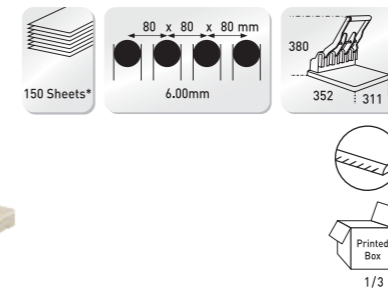

Spring assisted high leverage action for easy operation. 4 hole punch. Punches through 150 sheets of paper. All metal robust construction, Guide bar. Anti skid feet to avoid desk top from scratches.

## Replacement Spare Parts

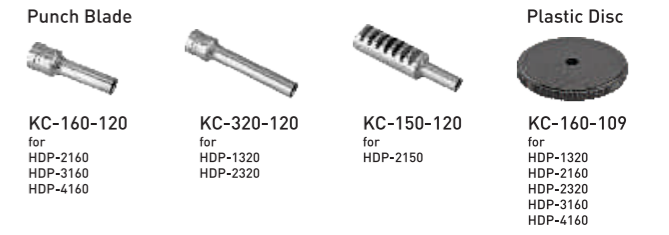

## FP-20

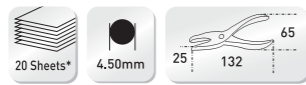

One hole handy punch with paper chip holder.

## HDP-1320



One hole punch for 290 sheets of paper. Spring assisted handle. All metal robust construction. Guide bar. Anti skid feet to avoid desk top from scratches.

## EP-20



One hole eyelet punch. Chrome plated all metal construction for strength and durability.

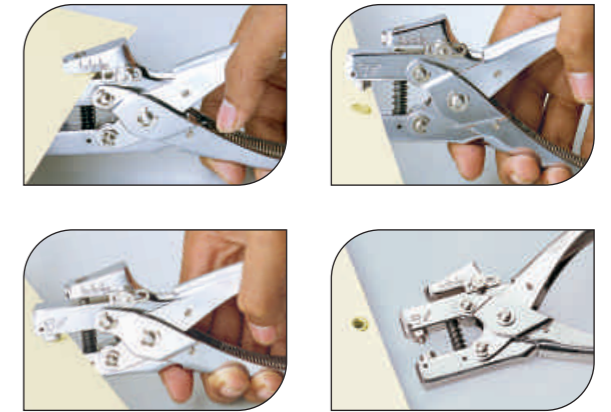

## HDP-2150

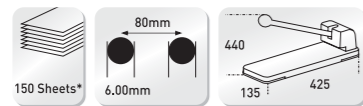

High leverage action for easy operation. 2 hole punch. Punches through 150 sheets of paper. All metal robust construction. Self centering guide bar. Anti skid base to avoid desk top from scratches.

## HDP-2160

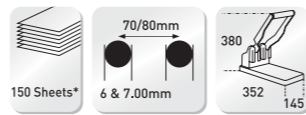

Spring assisted high leverage action for easy operation. 2 hole punch. Punches through 150 sheets of paper. All metal robust construction. Guide bar. Anti skid feet to avoid desk top from scratches.

## 2030

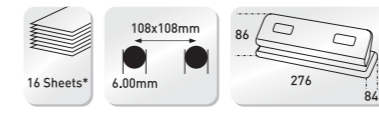

3 hole punch. All metal construction with guide bar. Removable chip tray.

## 4-HOLE

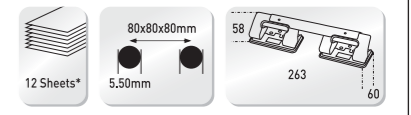

4 hole punch. All metal construction. Removable chip tray.

## HDP-2320

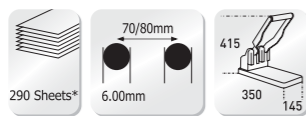

Spring assisted high leverage action for easy operation. 2 hole punch. Punches through 290 sheets of paper. All metal robust construction. Guide bar. Anti skid feet to avoid desk top from scratches.

## HDP-3160

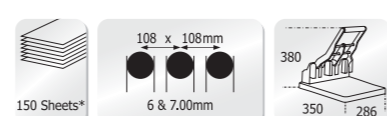

Spring assisted high leverage action for easy operation. 3 hole punch. Punches through 150 sheets of paper. All metal robust construction. Guide bar. Anti skid feet to avoid desk top from scratches.

## 2040

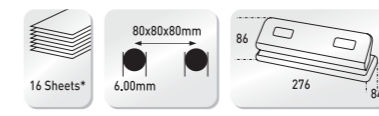

4 hole punch. All metal construction with guide bar. Removable chip tray.



# STAPLES

# TAPE DISPENSERS

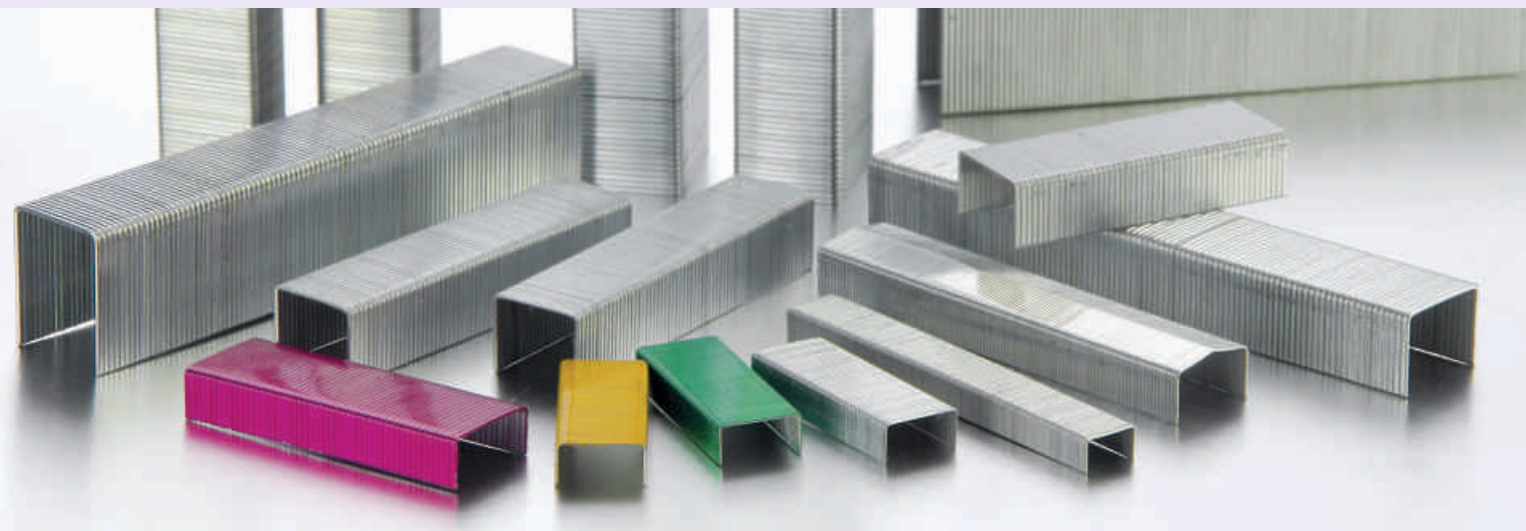

**No.10-1M**  
Strip : 50 nos.  
Packing : 1000 staples



**24/6-1M**  
Strip : 50 nos.  
Packing : 1000 staples



**26/6-1M**  
Strip : 100 nos.  
Packing : 1000 staples



**23/6**  
Strip : 100 nos.  
Packing : 1000 staples



**23/8-H**  
Strip : 100 nos.  
Packing : 1000 staples



**23/10-H**  
Strip : 100 nos.  
Packing : 1000 staples



**23/13-H**  
Strip : 100 nos.  
Packing : 1000 staples



**23/15-H**  
Strip : 100 nos.  
Packing : 1000 staples



**23/17-H**  
Strip : 100 nos.  
Packing : 1000 staples



**23/20-H**  
Strip : 100 nos.  
Packing : 1000 staples



**23/24-H**  
Strip : 100 nos.  
Packing : 1000 staples



## TD-110

### TAPE DISPENSER

- High impact ABS
- Handy & Versatile
- Quick and Easy to refill

### CLEAR TAPE

- Strong adhesion
- High age-resistance
- Outstanding transparency



## CC-110



TAPE DISPENSER...TD-110 - 1 Number  
CLEAR TAPE...18mm x 10mtr - 2 Numbers

## TD-18

### TAPE DISPENSER

- High impact ABS
- Stainless Steel Blade
- Compact & Lightweight

### CLEAR TAPE

- Strong adhesion
- High age-resistance
- Outstanding transparency



## TD-18/Y



TAPE DISPENSER... TD-18 - 1 Number  
CLEAR TAPE... 18mm x 24mtr - 1 Number





**CLAMSHELLS**

**TRENDY-10M/Z2**



**TRENDY-10M/Z5**



**TRENDY-10/Z4**



**BLISTERS**

**No.10-1M/Y2**



**M-10/Y2**



**MINI-10/Y2**



**TRENDY-10/Y2**



**HS-10H/Y2**



**DP-52/Y**



**DP-280/Y**



**PERFO-10/Y**



**LE-10/Y**



**LE-35/Y**



**M-10/Y2K**



**TD-18/Y**



**STATIONERY SETS**

**SS-10H**



**SS-T10M**



**DESK ESSENTIAL**

**DE-MINI 10**



*Your Perfect Companion  
at Work and Beyond.  
Now and Always.*



**EXCLUSIVE GIFT options for different segments like:**

- Finance & Insurance
- Automation Industry
- Hotels & Restaurants
- Pharmaceutical & Chemicals
- Education & Training Research
- Construction Tools & Machinery
- FMCG
- Home Appliance
- Electronic
- Information Technology



Stationery Sets



Box

Right gifting sets you apart from competition

Gifting reinforces your brand

Gifting increases employee satisfaction & productivity

3 ways corporate gifting helps a business grow

**Our products are available to reinforce your brand**  
 As you want to personalise the products within your brand with Pad printing / Steel stamping.  
**Artwork:** We create visuals free of charge.  
**Logo:** Acceptable formats are .cdr, .ai, .eps, .pdf vector files.



Clamshells



Blisters